

A

B

C

D

A

B

C

D

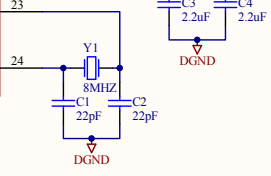
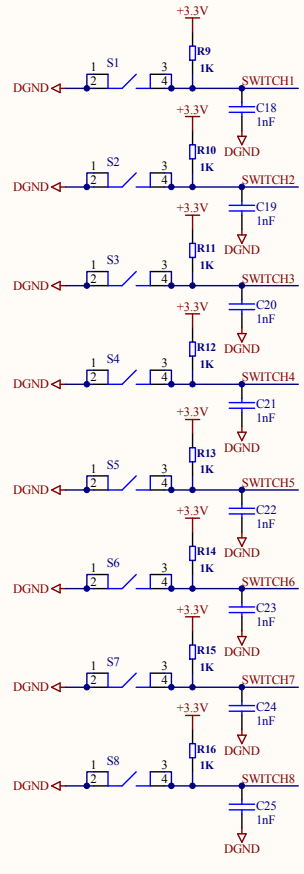
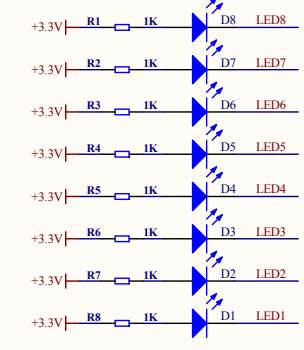
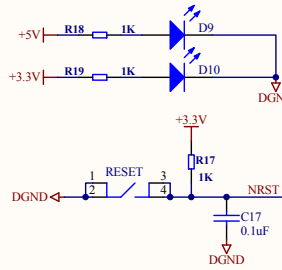
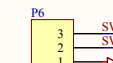
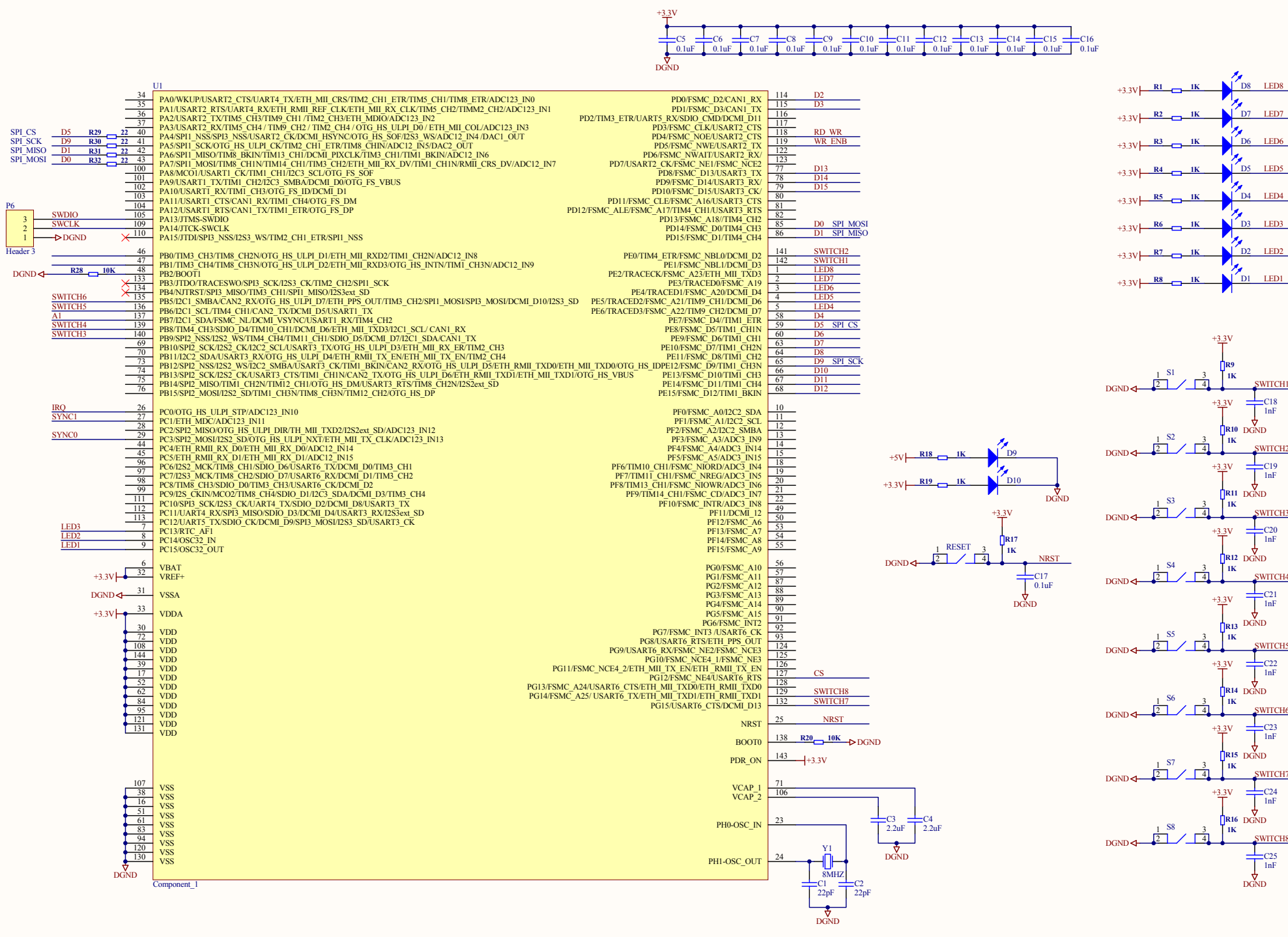

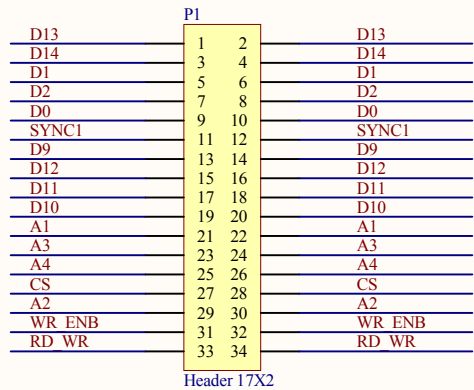
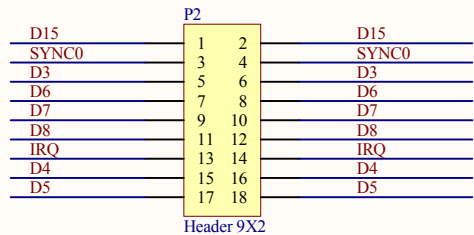
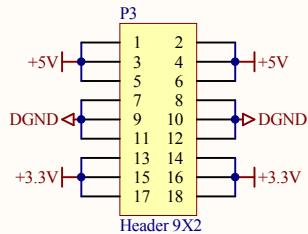
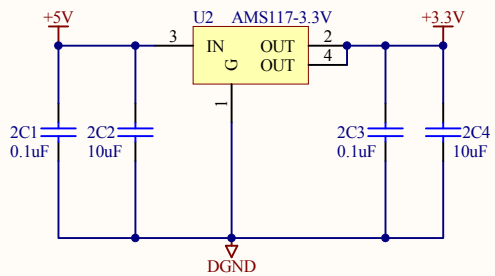
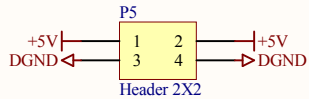
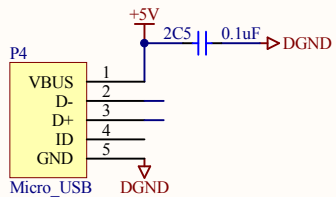

Title		
Size A4	Number	Revision
Date:	2020/4/25 星期六	Sheet of
File:	D:\0000000000000000\...02-Connector.Sch Drawn By:	